

RST TLED/ Pre-wired Reflector Strip Kit

The RST reflector strip kits are used to retrofit existing lamp fixtures for energy savings and improved lighting. This kits' optics, universal configuration, and adjustable clip strip bracketing system is an ideal fit for almost any stairwell hallway, school, parking garage, industrial or commercial location.



Project Name: _____ Type: _____

Catalog Number: _____ Date: _____

SPECIFICATIONS

Features

- Available in 4' and 8' lengths
- Quick and easy maintenance
- DLC listed tubes are included when ordered with PureLED tubes
- Economical upgrade to replacing surface mount or older fixtures
- Provides contractors and distributors UL listed kits specifically designed for use with Pure LED T8 LED tubes
- Low cost configurations using AC line voltage direct to PureLED tubes
- Patented "Clip Strip" bracket is reversible, allowing the same bracket to be used for different lamp configurations
- Designed and assembled in the U.S.
- Utility rebate friendly

Construction

- Hard tooled rounded edges for installer safety
- Extruded white gloss aluminum
- Custom-made multi-stage roll formed reflector
- Streamlined packaging for easy job site material management

Electrical

- 120/277 VAC universal voltage
- Pre-wired shunted and unshunted lamp holders

Optics

- 14 watt tube configurations available

Warranty

- 5-year limited warranty

CERTIFICATIONS



ORDERING INFORMATION

| TYPE | DIMENSIONS | LAMP CONFIGURATIONS ^A | LAMP SIZE | REFLECTOR | BRACKET | VOLTAGE | BALLAST | LAMP OPTIONS |
|------|------------|----------------------------------|------------|------------------|-----------------------------|--------------------------|--------------------------------------|-------------------------------|
| RST | 4 1 x 4 | 1 1 Lamp | T8 TLED | W White (91%) | CS Clip Strip Adjustable | U Universal (120/277) | N Normal (0.85-1.00) | Blank Without tubes |
| | 8 1 x 8 | 2 2 Lamp | | | | | S Single Ended AC (No ballast) | PL1440AB PureLED 14W 4000K |
| | | 4 4 Lamp | | | | | D Dual Ended AC (No ballast) | PL1740AB PureLED 17W 4000K |
| RST | | | | | | | | |

Example Ordering Number: **RST44T8WCSUNPL1440AB**

^A4ft RST is available in 1 lamp and 2 lamp configurations

^A8ft RST is available in 2 lamp and 4 lamp configurations

RST TLED/ Pre-wired Reflector Strip Kit

PHOTOMETRIC DATA

Below is the photometric data information for a 4' 2 lamp TLED fixture with 17w tube.

Zonal lumen summary

| ZONE | LUMENS | % OF FIXTURE |
|--------|--------|--------------|
| 0-30 | 966 | 22.6 |
| 0-40 | 1600 | 37.4 |
| 0-60 | 2997 | 70.0 |
| 0-90 | 4279 | 100.0 |
| 90-120 | 0 | 0.0 |
| 90-150 | 0 | 0.0 |
| 90-180 | 0 | 0.0 |
| 0-180 | 4279 | 100.0 |

Polar plot

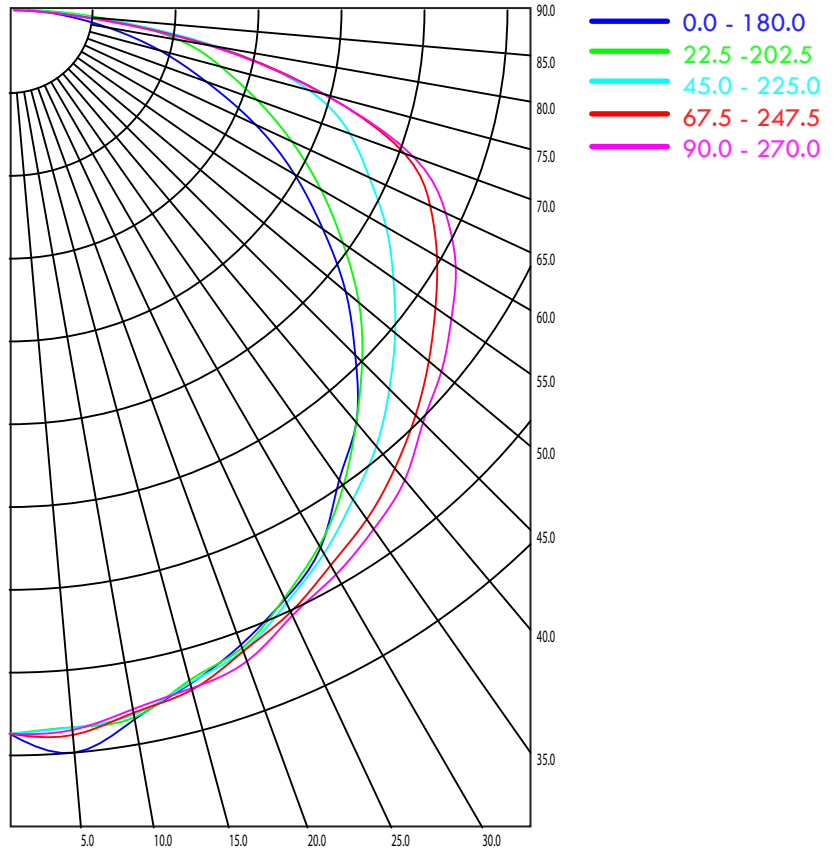

RST TLED/ Pre-wired Reflector Strip Kit

FIXTURE DIMENSIONS

1x4 2 Lamp

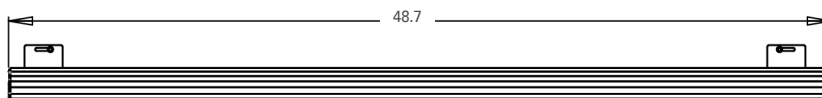
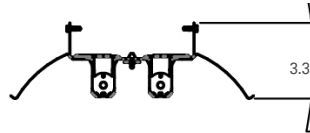
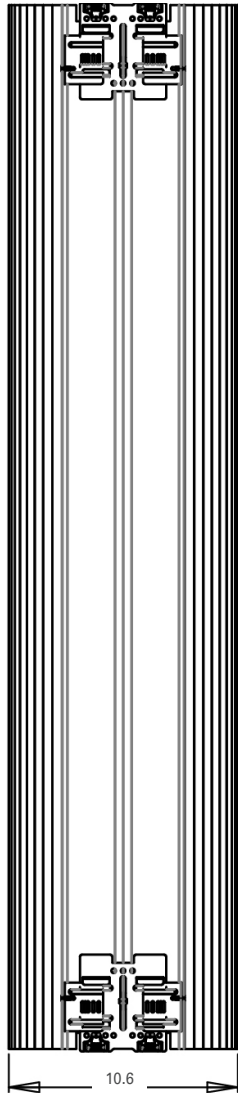

RST TLED/ Pre-wired Reflector Strip Kit

FIXTURE DIMENSIONS

1x8 4 Lamp

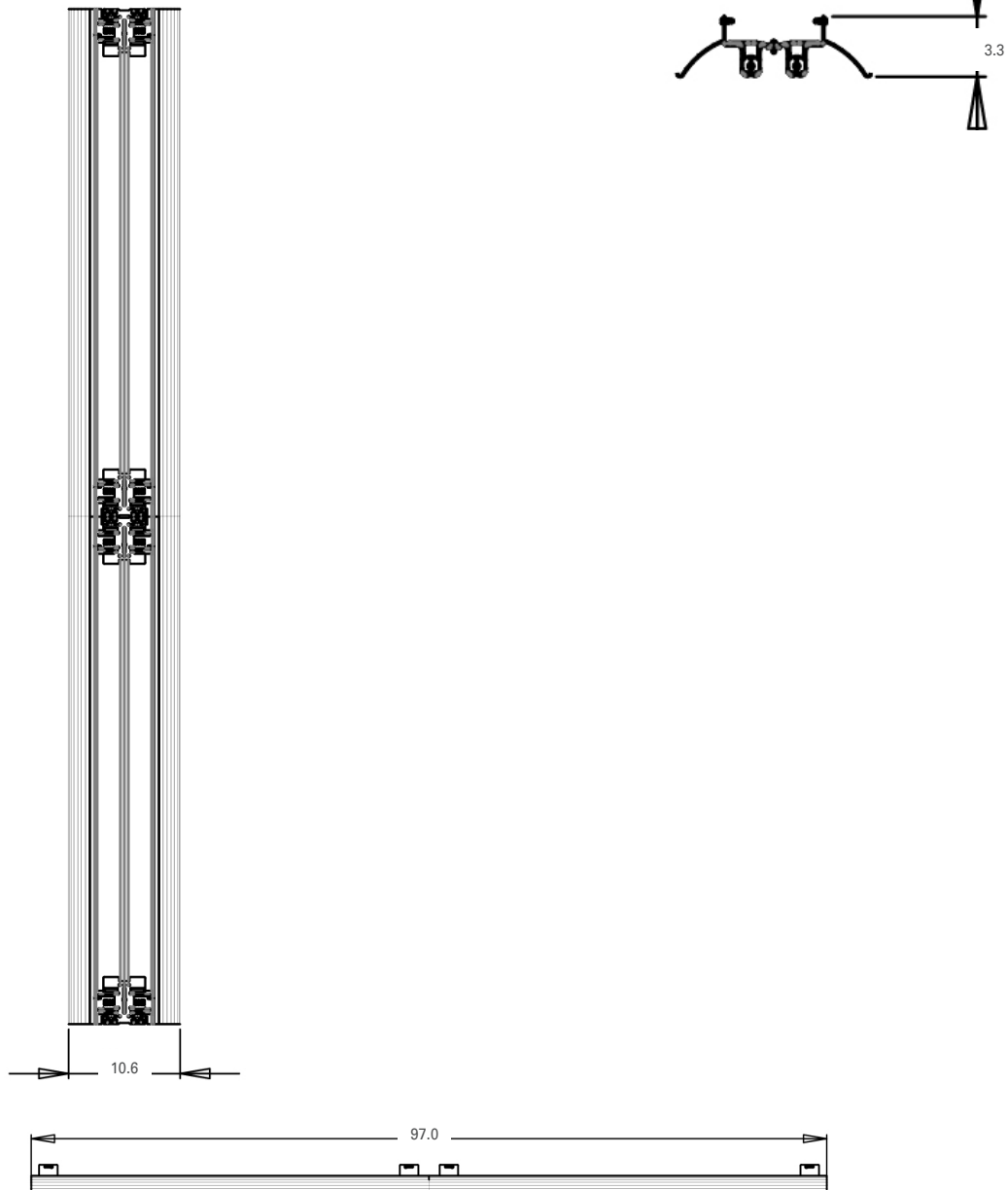

PSH / Pre-wired Strip Harness

The Envirobrite PTH is a pre-wired strip harness that is meant to be used to retrofit an existing strip and LED tubes.



Product Image
Coming Soon

Project Name: _____ Type: _____

Catalog Number: _____ Date: _____

STRIP RETROFIT ACCESSORIES

4' - 1 lamp

| Part # | Description |
|-----------|---|
| PSH41T8UN | 1-Lamp Wiring Harness for LED tubes with ballast; Includes (1) Pre-wired tall, non-shunted sockets with power quick disconnects |
| PSH41T8US | 1-Lamp Wiring Harness for LED tubes with single ended AC; Includes (1) Pre-wired tall, non-shunted sockets with power quick disconnects |
| PSH41T8UD | 1-Lamp Wiring Harness for LED tubes with dual ended AC; Includes (1) Pre-wired tall, non-shunted sockets with power quick disconnects |

4' - 2 lamp

| Part # | Description |
|-----------|---|
| PSH42T8UN | 2-Lamp Wiring Harness for LED tubes with ballast; Includes (2) Pre-wired tall, non-shunted sockets with power quick disconnects |
| PSH42T8US | 2-Lamp Wiring Harness for LED tubes with single ended AC; Includes (2) Pre-wired tall, non-shunted sockets with power quick disconnects |
| PSH42T8UD | 2-Lamp Wiring Harness for LED tubes with dual ended AC; Includes (2) Pre-wired tall, non-shunted sockets with power quick disconnects |

8' - 2 lamp

| Part # | Description |
|-----------|---|
| PSH82T8UN | 2-Lamp Wiring Harness for LED tubes with ballast; Includes (2) Pre-wired tall, non-shunted sockets with power quick disconnects |
| PSH82T8US | 2-Lamp Wiring Harness for LED tubes with single ended AC; Includes (2) Pre-wired tall, non-shunted sockets with power quick disconnects |
| PSH82T8UD | 2-Lamp Wiring Harness for LED tubes with dual ended AC; Includes (2) Pre-wired tall, non-shunted sockets with power quick disconnects |

8' - 4 lamp

| Part # | Description |
|-----------|--|
| PSH84T8UN | 4-Lamp Wiring Harness for LED tubes with ballast; Includes (4) Pre-wired, non-shunted sockets with power quick disconnects |
| PSH84T8US | 4-Lamp Wiring Harness for LED tubes with single ended AC; Includes (4) Pre-wired, non-shunted sockets with power quick disconnects |
| PSH84T8UD | 4-Lamp Wiring Harness for LED tubes with dual ended AC; Includes (4) Pre-wired, non-shunted sockets with power quick disconnects |

PSH/ Pre-wired Strip Harness

ADDITIONAL INFORMATION

4' - 1 lamp with ballast



4' - 1 lamp with single ended AC

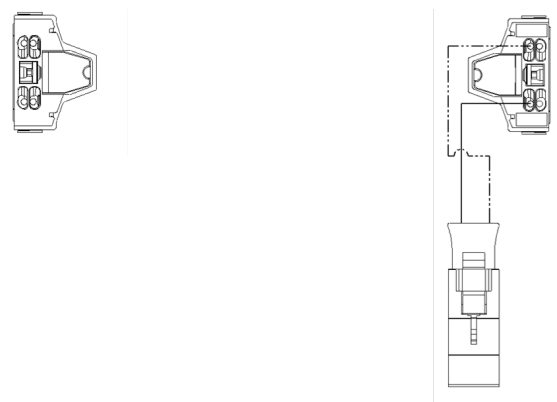

4' - 1 lamp with dual ended AC

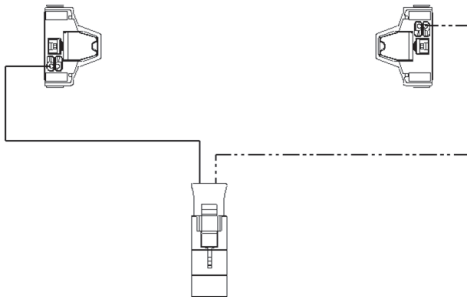

4' - 2 lamp with ballast

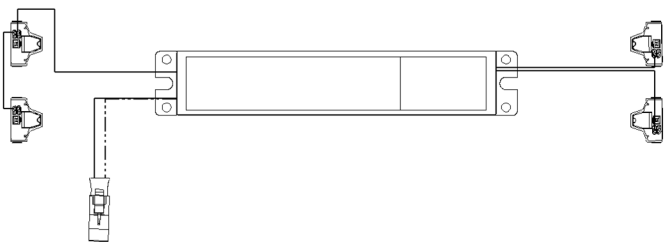

4' - 2 lamp with single ended AC

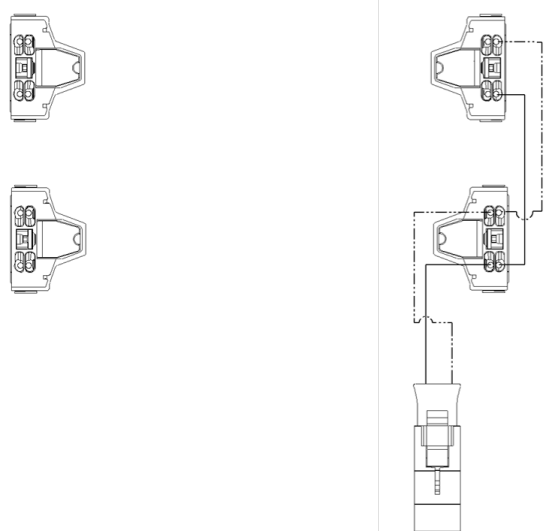

4' - 2 lamp with dual ended AC

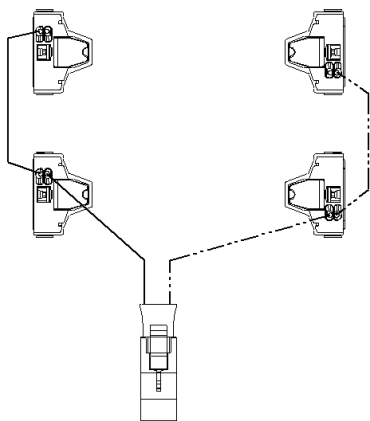

PSH/ Pre-wired Strip Harness

ADDITIONAL INFORMATION

8' - 2 lamp with ballast

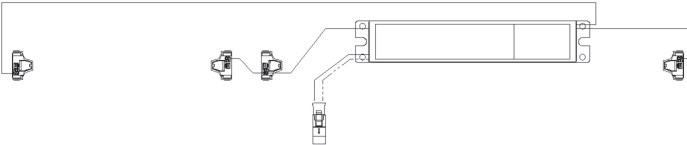

8' - 2 lamp with single ended AC

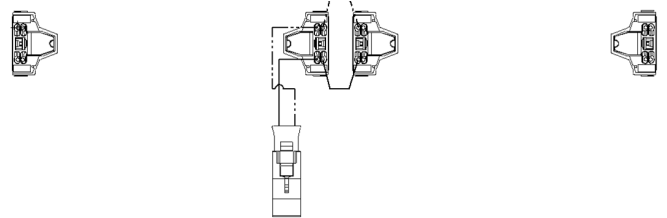

8' - 2 lamp with dual ended AC

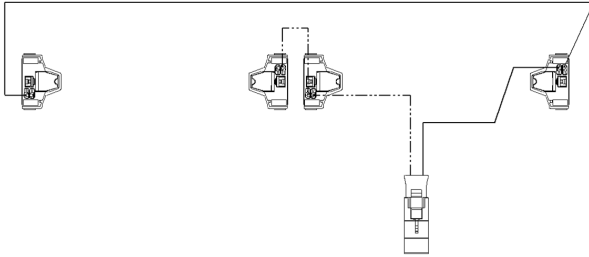

8' - 4 lamp with ballast

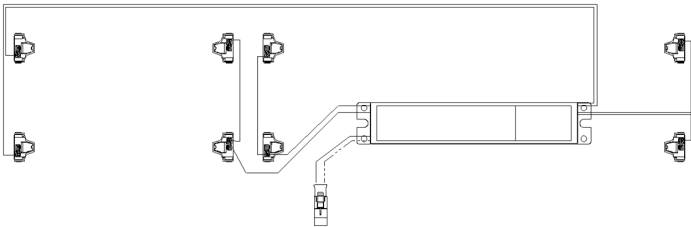

8' - 4 lamp with single ended AC

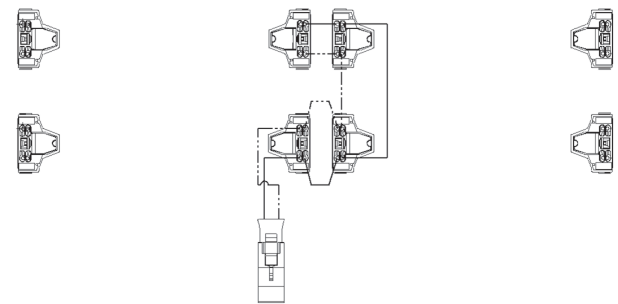

8' - 4 lamp with dual ended AC

