



DECO | LIGHTING

D404-LED

Large Wall Pack

Job Information

Type:	
Catalog #:	
Project:	
Comments:	
Prepared by:	

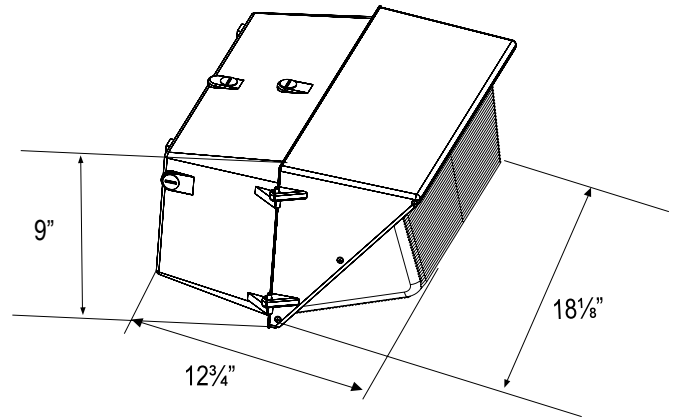
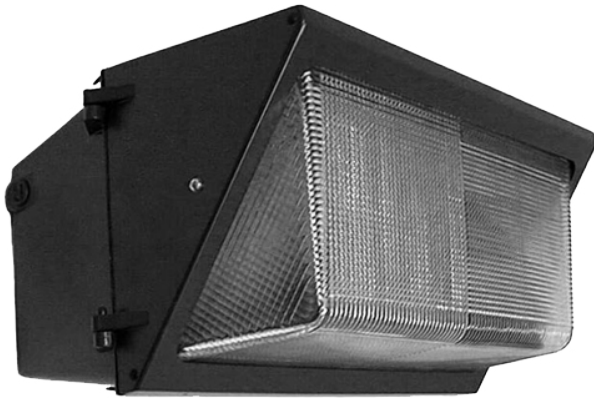

Description

The D404-LED large low profile wall pack offers reliable performance with a wide range of uses. It delivers the lighting needed for the exteriors of retail buildings, businesses, walkways, underpasses or door entrances.

Ordering Information

Example: (D404-LED-120-40-UNV-WH-PC)

D404-LED

Series	Wattage/Lumen	Color Temp.	Voltage	Finish	Option
Medium Curved	20 20W/2106 ^{3,5}	30 3000K ⁵	UNV 120-277V	BZ Bronze ¹	PC Photocell
Semi-Cutoff	40 40W/4257 ^{3,5}	35 3500K ⁵	347 347V	BL Black	WG Wire Guard
Wall Pack	60 60W/6090 ³	40 4000K	480 480V	WH White	MS Motion Sensor w/Dimming (FSP-211)
	80 80W/9073 ^{3,5}	50 5000K ^{4,5}	(Step-Down Transformer used for 480V Divider)	CU Custom ²	FC Full Cutoff Visor (Dark Sky Compliant) ⁵
	100 100W/10061 ^{3,5}				SC Side Cutoff
	120 120W/12812 ^{3,5}				VR Polycarbonate Vandal Resistant Guard
					EM Emergency Battery ⁶

¹ Standard finish color

² Contact factory for custom finish

³ Delivered Lumens (5000K)

⁴ Standard Color Temp.

⁵ DLC Listed Wattage - View DLC matrix on Page 4 for list of all variants currently listed.

⁶ EM option only available on packages 80W and below

Deco Lighting practices a program of continuous product development, and as a result product specifications change frequently. We reserve the right to change product specifications without notice. Contact Deco for the latest product information.

©2018 Deco Lighting, www.getdeco.com T: (800) 613-DECO F: (310) 366-6855
Rev Date: 03/01/18 #8



Digitize your light.®

Features

- Heavy duty two piece, die-cast aluminum housing with a textured bronze UV resistant finish over a chromate conversion coating.
- Specular anodized aluminum reflector.
- Silicone gasketing provides protection against moisture.
- Mounts directly to 3.5" octagon or 4" square outlet box.
- .5" NPS tapped holes provided in three locations for surface conduit entry or optional photo control.
- Clear prismatic borosilicate glass refractor is thermal and shock resistant.
- Integral cast-in aluminum hinges permit complete removal of lens frame assembly without tools.
- Front housing is hinged for easy relamping and is complete with silicone gasket seal.
- DLC-listed for utility rebates (View DLC matrix on Page 4 for more info)
- Dark Sky compliant when ordered at 3000K with Full Cutoff Visor

Photometric Data

To see complete photometric reports or download ies files for this product visit the Deco Lighting D404-LED homepage. Tested in accordance with IESNA LM-79 and LM-80 standards.

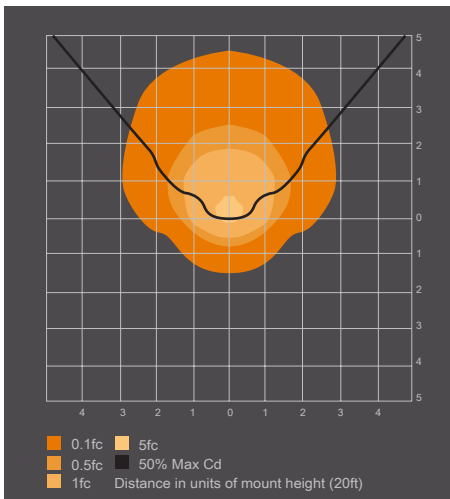

Delivered Light Output & Equivalency Chart

HID to LED Replacement		
DELIVERED LUMENS	HID	LED Replacement
1300lm	50W	10W
2600lm	70W	20W
3900lm	100W	30W
5200lm	150W	40W
7800lm	175W	60W
11700lm	250W	80W
15600lm	400W	120W
26000lm	750W	200W
31200lm	1000W	240W

Interested in upgrading from HID to LED lighting? Use the conversion table below to get a general idea of what wattage LED fixture will replace your current lighting system. Lumen output and overall performance will vary by fixture, so please contact our factory or your nearest sales rep regarding specific questions on what wattage will best suit your desired space and application.

Performance Data

CRI:	80+
CCT:	3000K, 3500K, 4000K, 5000K
Warranty:	10 yr. Limited Warranty
Dimming:	Available with 0-10V inputs dimming down to 10%
Operating Temperature:	-30°C to +60°C Ambient
L70 Rating:	100,000+ Hours
IP Rating:	IP66
Sound Rating:	Class A (inaudible in a 24dB ambient environment)
Power Factor:	>0.95
Total Harmonic Distortion:	<20%

Lumen Output

Lumen Chart				
Wattage	5000K	4000K	3500K	3000K
20	2106	2001	1975	1959
40	4257	4044	3993	3959
60	6090	5481	5207	4686
80	9073	8620	8511	8438
100	10061	9558	9437	9357
120	12812	12171	12018	11915

*Lumen outputs are based on 5000K lumen data and then scaled down to other color temperatures

Motion Sensor with Dimming

FSP-211

The FSP-211 mounts in an outdoor lighting fixture and provides multi-level control based on motion. The sensor also includes a photocell to measure the ambient light level. It controls 0-10 VDC LED drivers or dimming ballasts, as well as non-dimming ballasts and with an SFP-LX Lens, is rated for wet and cold locations. All control parameters are adjustable via a wireless configuration tool capable of storing and transmitting sensor profiles.

Key Factors:

- Full adjustable high and low dimmed light levels.
- Designed for LED fixtures; rated for extreme temperatures and up to 200,000 on/off cycles
- Hold off set point with automatic calibration option for convenience and added energy savings
- Adjustable via hand-held wireless configuration tool
- IP66 rated with choice of lenses for wet and outdoor locations and mounting heights from 8'
- Adjustable time delay and cut off delay



Coverage & Dimensions

The FS-Lx lenses work with FSP-211 motion sensors to provide multi-level lighting control based on motion and the ambient light level. Four lens choices provide flexibility for varying mounting heights.

FSP-L2

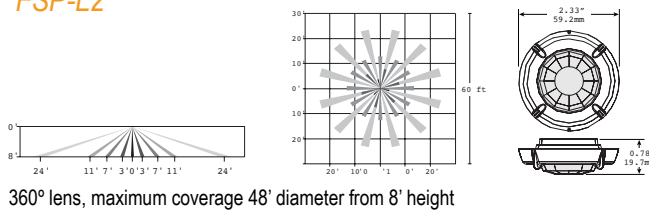

FSP-L4

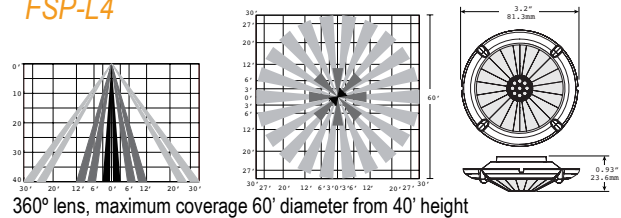

FSP-L3

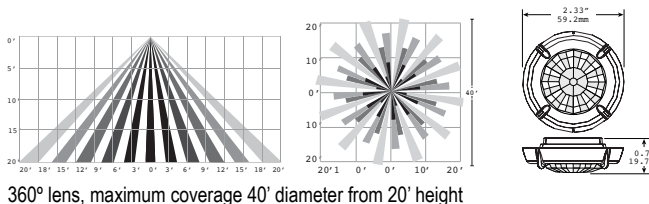

FSP-L7

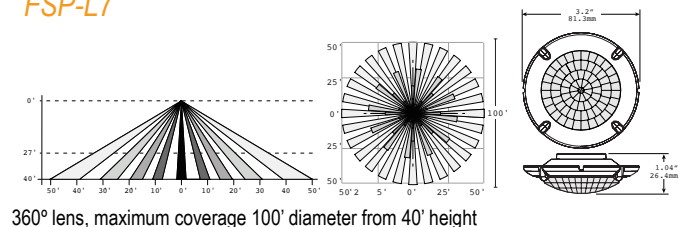

Options & Accessories

Prismatic Glass Lens	Full Cutoff *Required for DLC & Dark Sky Compliance	Side Cutoff
		
		
Polycarbonate Lens Guard	Wire Guard	

DLC Listing

	20W	40W	60W	80W	100W	120W
3000K	X	X		X	X	X
3500K						
4000K	X	X		X	X	X
5000K	X	X		X	X	X